

Engine 3TNV70
Engine power 11,2 kW - 15,2 HP
Operating Weight 1.730 - 1.810 kg

ES 18 ZT

Concrete solutions. Always



TECHNICALS SPECIFICATIONS

Operating weight with canopy (with rubber tracks)	kg	1.730
Operating weight with cabin (rubber tracks)	kg	1.810
Travelling speed	km/h	1 ^a : 0 ÷ 2,2 / 2 ^a : 0 ÷ 4,2
Slew speed	rpm	12
ENGINE		
Type	YANMAR 3TNV70	
Power (2.100 rpm)	kW - HP	11,2 - 15,2
Displacement	cc	854
Number of cylinders	n°	3
Cooling	water	
Consumption	lt/h	2,4
Alternator	V (A)	12 (35)
Battery	V (Ah)	12 (65)
HYDRAULIC SYSTEM		
Pump type	variable flow	
Pump displacement	cc	8+8+6,5
Pump capacity	lt/min	17,6+17,6+14,3
Max. circuit calibration pressure	bar	210
Auxiliary system:	Max capacity	lt/min 36
	Max pressure	bar 210
PERFORMANCES		
Max digging depth standard arm (optional arm)	mm	2.300 (2.500)
Max dumping height with canopy standard arm (optional arm)	mm	2.530 (2.625)
Max dumping height with cab standard arm (optional arm)	mm	2.530 (2.635)
Bucket breaking force (standard arm) ISO 6015	daN	1.550
Arm breaking force (standard arm) ISO 6015	daN	1.050
Traction force	daN	1.500
Ground bearing pressure with rubber tracks and canopy (with cabin)	kg/cm ²	0,32 (0,33)
Max slope	60% - 30°	
DIMENSIONS		
Maximum width	mm	990 - 1.300
Total height	mm	2.357
Rear rotation radius	mm	650
Digging arm length standard (optional)	mm	1.150 (1.350)
Tracks width	mm	230
Rollers number (for each side)	n°	3
FILLINGS		
Fuel tank	lt	18
Hydraulic oil tank	lt	20
Hydraulic circuit capacity	lt	30
Cooling system capacity	lt	4
Engine oil	lt	2,8
CONTROLS		
Boom, dipper stick, bucket and turret swing	2 pilot joysticks	
Track movements (included counter rotation)	2 levers	
Dozer blade	mechanical lever	
Auxiliary circuit (simple or double effect)	left pedal	
Boom swing	right pedal	

ES 18 ZT

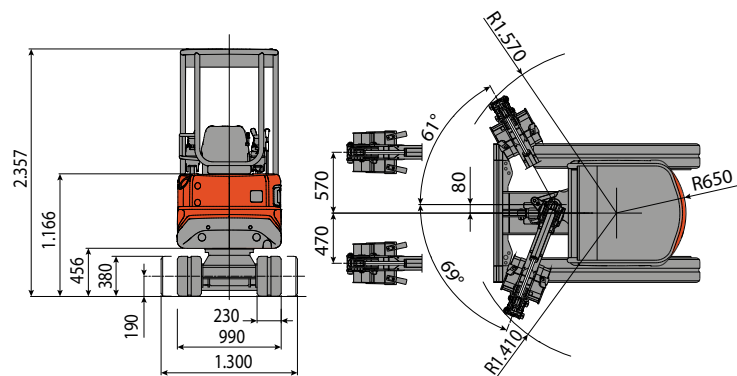
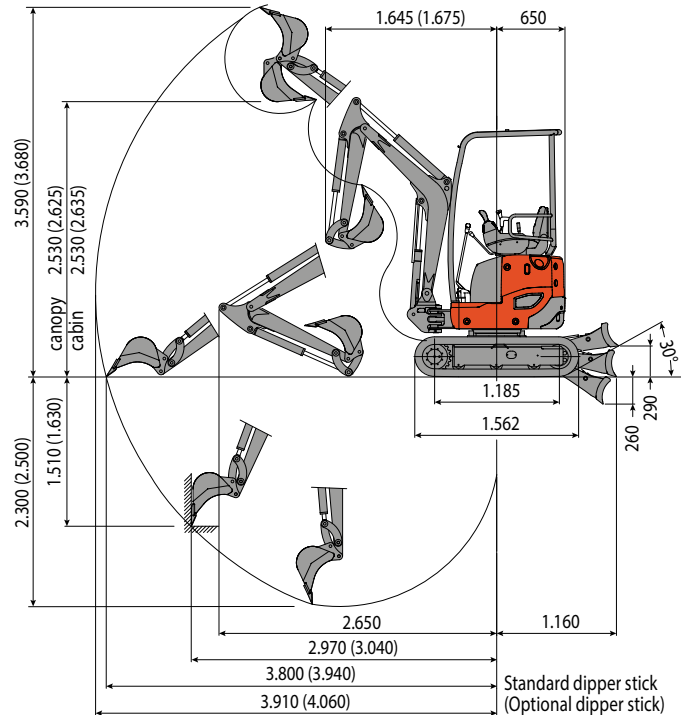

LIFTING CAPACITY					
Opening arm from the rotation's center (m)					
Lifting capacity (kg) at 1.0 m height					
	1,5	2	2,5	3	MAX
Frontal and lowered dozer blade	660	440	360	310	250
Frontal and lifted dozer blade	610	410	280	205	180
Lateral, open undercarriage	610	410	235	195	160

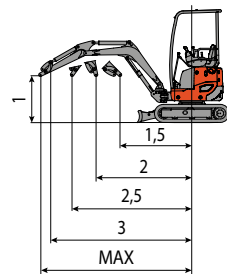

The lifting capacity is based on the ISO 10567 and it does not exceed more than the 75% of static tipping load or more than the 87% of the hydraulic lifting capacity of the machine.



EUROCOMACH®

Sampierana S.p.A.

47021 S.Piero in Bagno (FC)

via Leonardo da Vinci, 40

Tel +39 0543.904211

Fax +39 0543.918520

www.eurocomach.com